

Operating Instructions



Sunroof:
Doc.-No.:
Date:

Hollandia 300, 500, 600, 700, 710
0912033A
20-04-2004





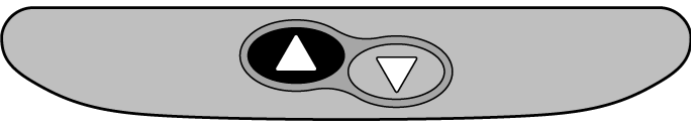
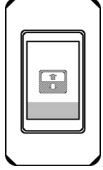

Operating the sunroof

1. Control panels (electric and electronic versions)

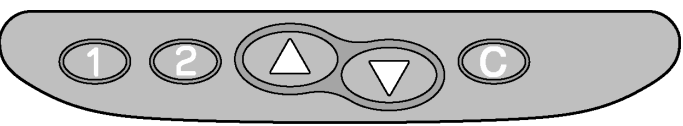
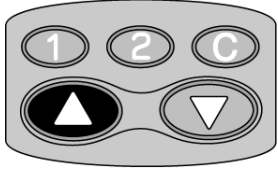
Electric versions

| | |
|---------------------------------------------------------------------------------------------------------------------------------------------------------------------------------------------------------------|---------------------------------------------------------------------------------------------------------------------------------------------------------------------------------------------------------------|
|  <p>Hollandia 300 DeLuxe versions without sliding sunshade (with or without sunrollo), Hollandia 500 FreeDome</p> |  <p>Hollandia 600, Hollandia 300 Classic and Hollandia 300 DeLuxe versions with sliding sunshade</p> |
|  Open |  Close |

Full electronic versions

| | |
|---------------------------------------------------------------------------------------------------------------------------------------------------------------------------------------------------------------------------------------------------------------------------------------------------------------------------|--------------------------------------------------------------------------------------------------------------------------------------------------------------------------------------------------------|
|  <p>Hollandia 500 and Hollandia 300 DeLuxe versions without sliding sunshade, with or without sunrollo</p> |  <p>Hollandia 700 and Hollandia 300 DeLuxe versions with sliding sunshade</p> |
|  Pre-set position 1  Pre-set position 2  Tilt / slide open |  Slide close  One touch close |

Note: pictures shown in this manual refer to Hollandia 300 DeLuxe Medium, if not stated otherwise. Therefore minor details in pictures can vary from your sunroof.

Operating Instructions

Sunroof:
Doc.-No.:
Date:

Hollandia 300, 500, 600, 700, 710
0912033A
20-04-2004

2. Operating manual versions

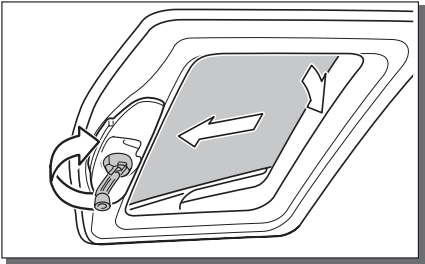
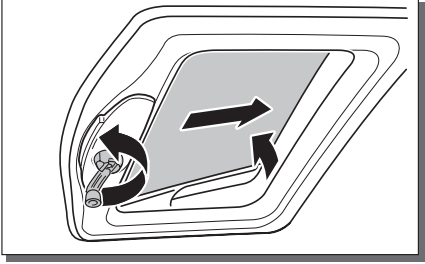
| | |
|-----------------------------------------------------------------------------------|------------------|
|  | Opening sunroof. |
|  | Closing sunroof. |

Operating Instructions

Sunroof:
 Doc.-No.:
 Date:

Hollandia 300, 500, 600, 700, 710
 0912033A
 20-04-2004

3. Operating electric versions

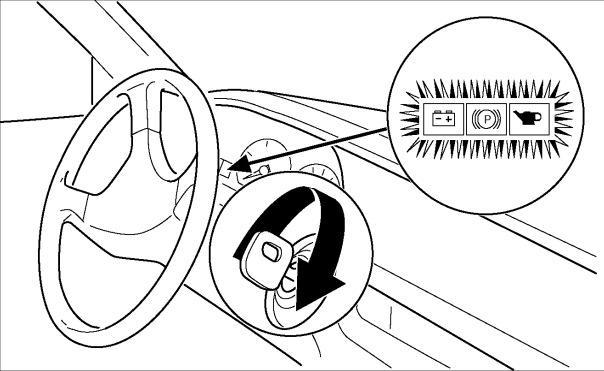
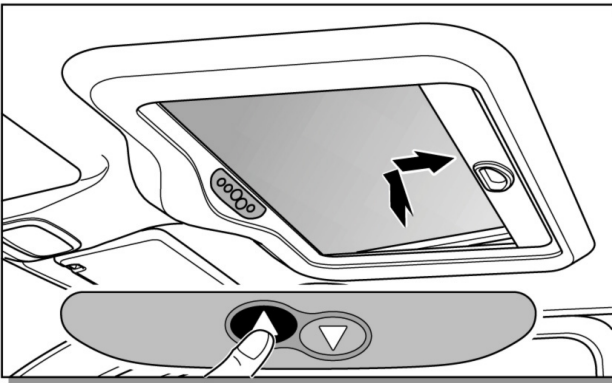
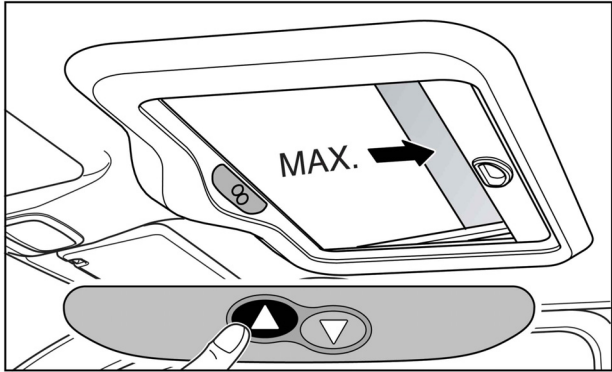
| | |
|-------------------------------------------------------------------------------------------------------------------------------------------------------------------------------------------------------------------------------------|--------------------------------------------------------------------------------------------------------|
|  | <p>Switch on ignition.</p> |
|  <p>Maximum tilt position</p>  <p>Maximum sliding position</p> | <p>Press ▲-button to open sunroof. Release button when sunroof is in position you like.</p> |

Operating Instructions

Sunroof:
Doc.-No.:
Date:

Hollandia 300, 500, 600, 700, 710
0912033A
20-04-2004

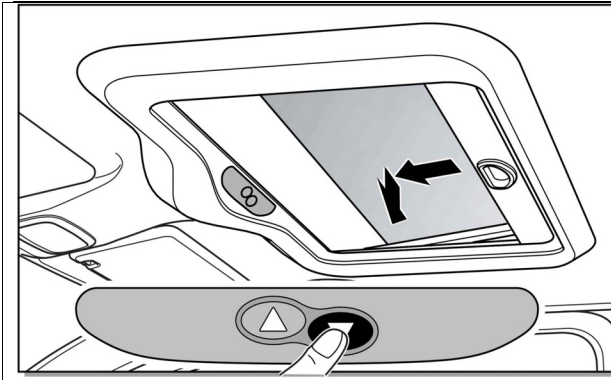

Closing completely.

Operating Instructions

Sunroof:
 Doc.-No.:
 Date:

Hollandia 300, 500, 600, 700, 710
 0912033A
 20-04-2004

3. Operating full electronic versions

3.1. Programming the sunroof before using it the first time

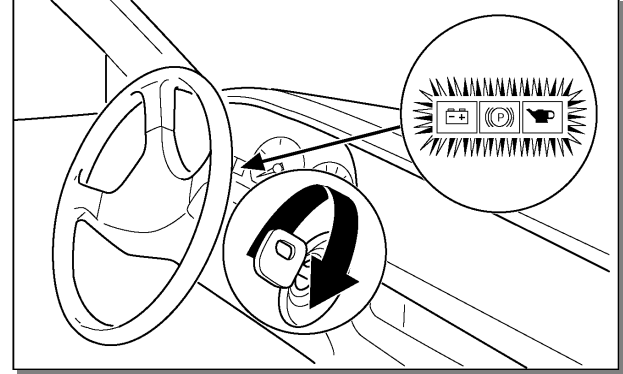
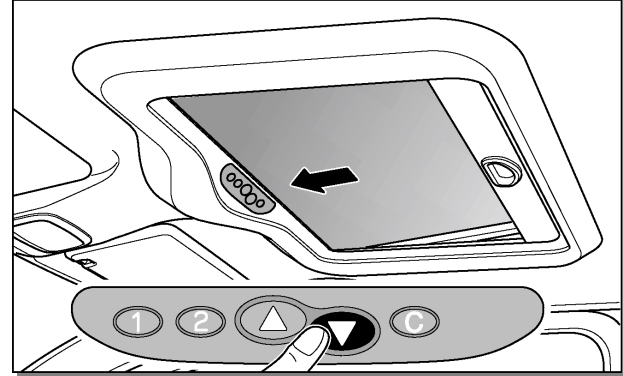
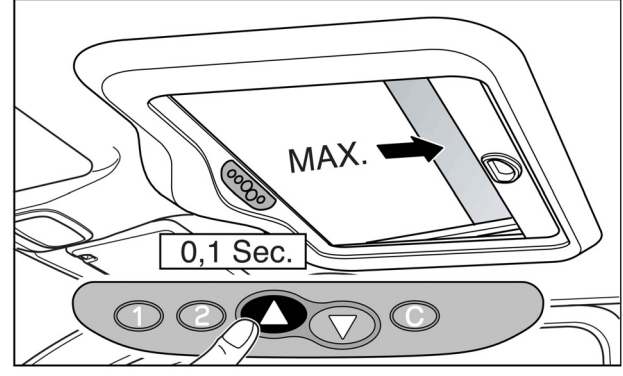
| | |
|-------------------------------------------------------------------------------------|-----------------------------------------------------------------------------------------------------------------------------------|
|  | <p>Switch on ignition.</p> |
|  | <p>Close sunroof completely, release switch, press again and hold ▼-button for at least 5 seconds.</p> |
|  | <p>Open sunroof completely (therefore briefly press ▲-button), a click will indicate end position. Sunroof is programmed now.</p> |

Operating Instructions

Sunroof:
Doc.-No.:
Date:

Hollandia 300, 500, 600, 700, 710
0912033A
20-04-2004

3. 2. Opening of the sunroof

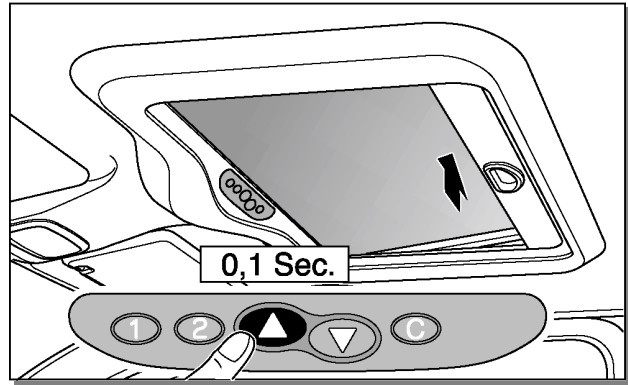
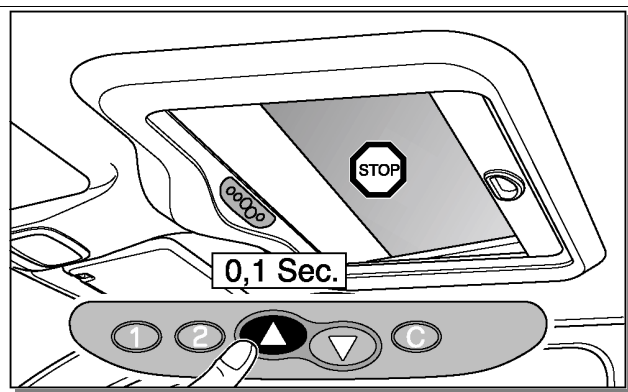
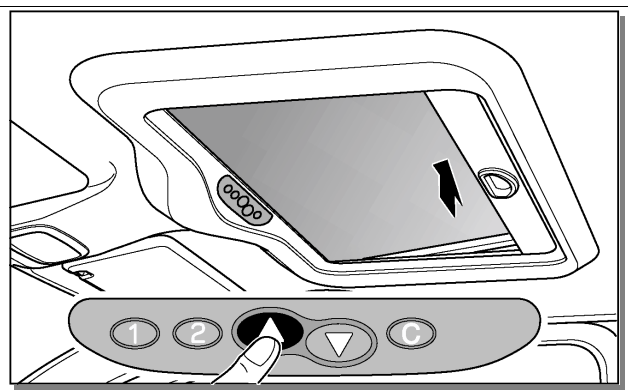
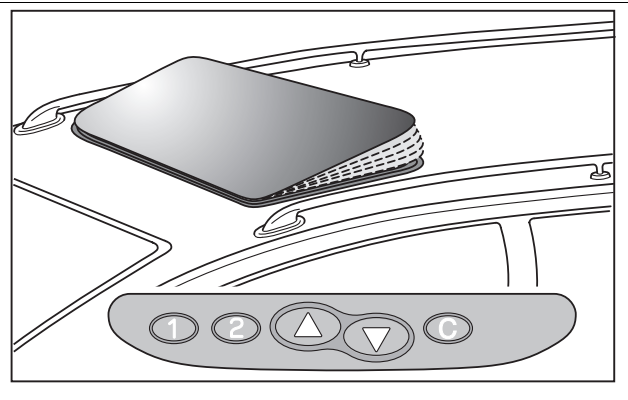
| | |
|-------------------------------------------------------------------------------------|-------------------------------------------------------------------------------------------------------------------------------------------------------------------|
|  | <p>Opening sunroof into sliding position: With ignition switched on, press ▲-button shortly.</p> |
|  | <p>Press ▲-button shortly again when glass panel reached desired position.</p> |
|  | <p>Opening of sunroof in max. tilt position: With ignition on, press open button continuously, release button when panel is in max. tilt position.</p> |
|  | <p>By pressing button ▲ or ▼ continuously, panel is adjustable in 4 different positions. When button is released, roof remains in momentary position.</p> |

Operating Instructions

Sunroof:
 Doc.-No.:
 Date:

Hollandia 300, 500, 600, 700, 710
 0912033A
 20-04-2004

3.3. Closing of sunroof

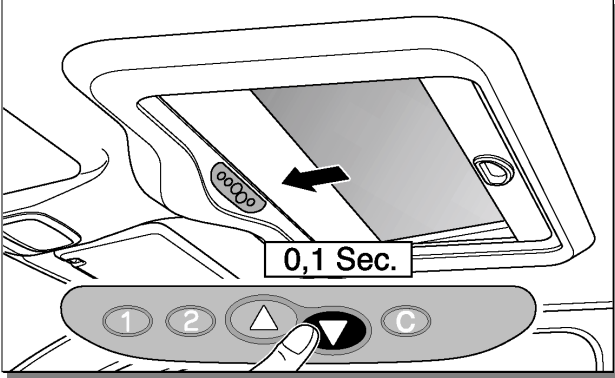
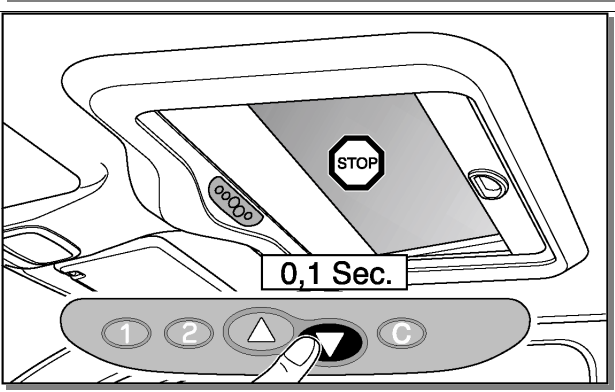
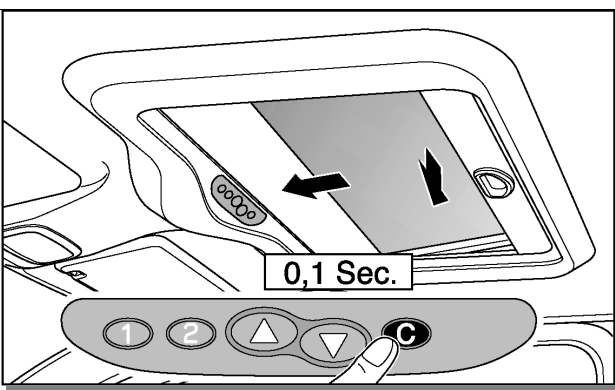
| | |
|-------------------------------------------------------------------------------------|----------------------------------------------------------------------------------|
|  | <p>When pressing ▼-button shortly, panel will close completely.</p> |
|  | <p>Pressing ▼-button shortly again will stop panel.</p> |
|  | <p>When pressing briefly ©-button, panel will close from any panel position.</p> |

Operating Instructions

Sunroof:
Doc.-No.:
Date:

Hollandia 300, 500, 600, 700, 710
0912033A
20-04-2004

3.4. Programming two pre-set positions

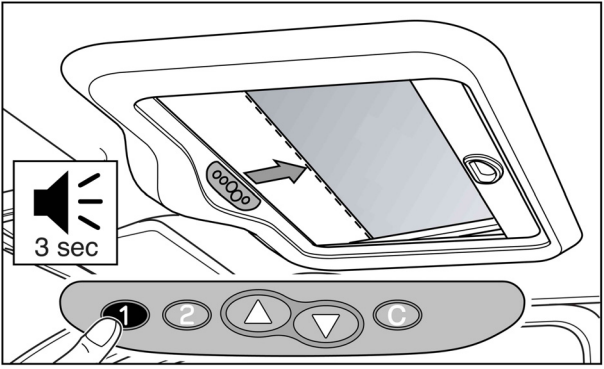
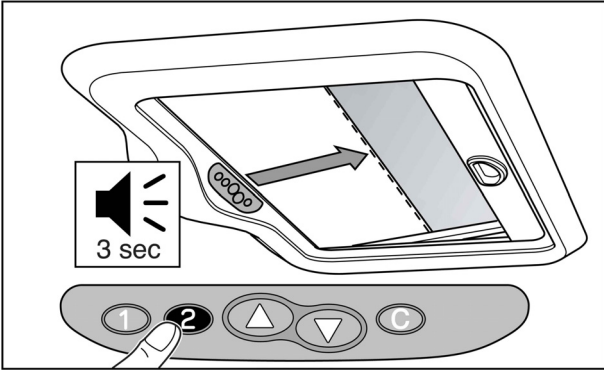
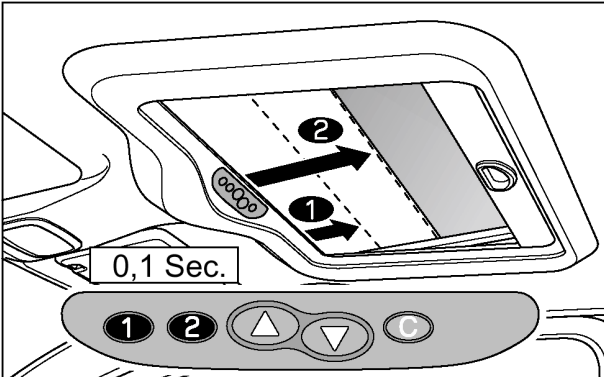
| | |
|-------------------------------------------------------------------------------------|-------------------------------------------------------------------------------------------------------------------------------------------------------------------------------------|
|  | <p>Place panel in first favoured position.</p> <p>Press 1-button for three seconds to store this position under 1-button.</p> <p>A beep will confirm programming.</p> |
|  | <p>Place panel in second desired position.</p> <p>Press 2-button for three seconds to store this position under 2-button.</p> <p>Beep will confirm programming.</p> |
|  | <p>Press button 1 or 2 to open panel to favoured positions.</p> <p>Repeat steps for programming new pre-set positions.</p> |

Operating Instructions

Sunroof:
Doc.-No.:
Date:

Hollandia 300, 500, 600, 700, 710
0912033A
20-04-2004

3.5. Auto close

| | |
|--|------------------------------------------------------------------------------------------------------------------------------|
| | <p>Switch off ignition. Sunroof beeps once to indicate that panel closes after three seconds.</p> |
| | <p>Panel closes. You hear 2 beeps.</p> |
| | <p>For preventing roof from closing automatically, press ▲-button briefly within 3 seconds after switching off ignition.</p> |

Operating Instructions

Sunroof:
 Doc.-No.:
 Date:

Hollandia 300, 500, 600, 700, 710
 0912033A
 20-04-2004

3.6. Jamming protection

| | |
|---------------------------------|-----------------------------------------------------------------------------------------------------------------------------------------------------------------------------------------------------------------------------------------------------------------------------------------------------------------|
| <p>1</p> <p>0,1 Sec.</p> | <p>When closing sunroof.....</p> |
| <p>2</p> | <p>.....sunroof opens automatically when panel encounters an obstacle.</p> |
| <p>3</p> | <p>When obstacle is removed, panel will close again. Jamming protection can be switched off by operating button continuously even when ignition is off.</p> <p> Do not leave children unattended in your car!</p> |



Operating Instructions

Sunroof:
 Doc.-No.:
 Date:

Hollandia 300, 500, 600, 700, 710
 0912033A
 20-04-2004

4. Annotations for electric and full electronic versions

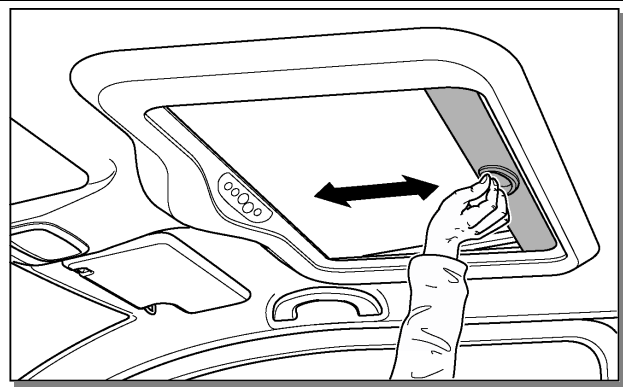
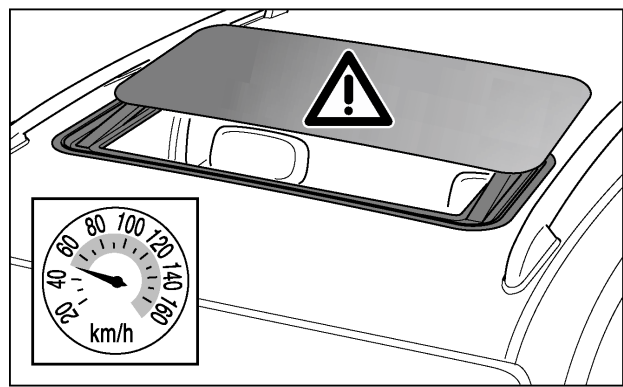
4.1. Operation of sunshade

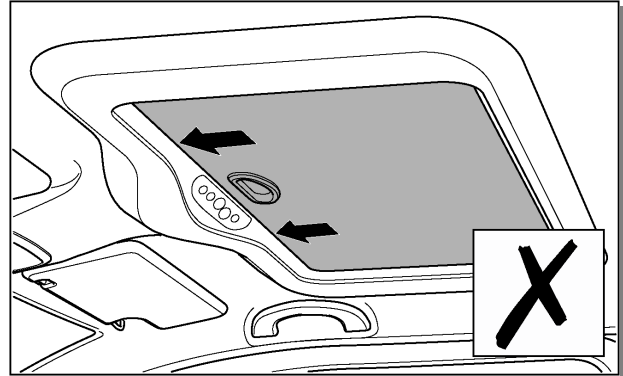
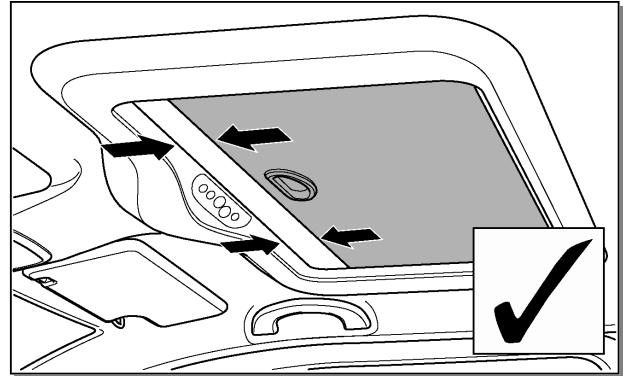





| | |
|-------------------------------------------------------------------------------------|------------------------------------------------------------------------------------------------------------------------------------------------------------------------------------------------|
|  | <p>Sunshade can be placed in every position.</p> |
|  | <p> Do not close sunshade completely at >50 km/h and open sunroof (vibrations!). Leave gap of >3cm.</p> |
|  | |
|  | |

Operating Instructions

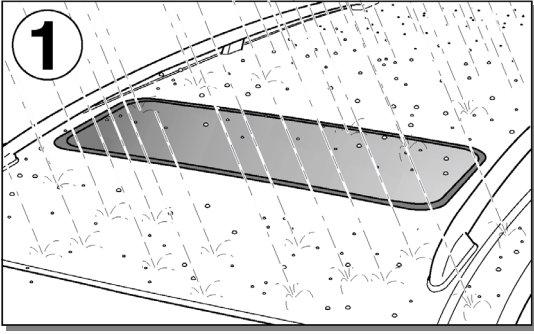
Sunroof:
 Doc.-No.:
 Date:

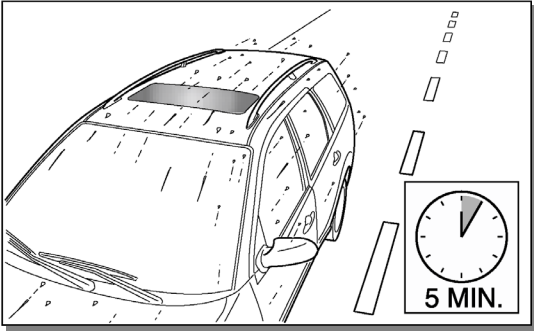
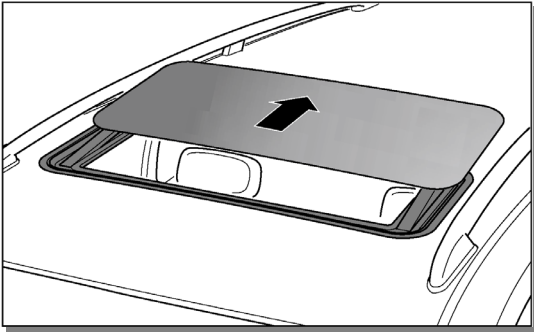
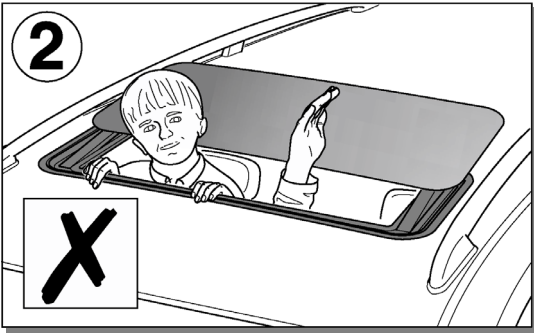
Hollandia 300, 500, 600, 700, 710
 0912033A
 20-04-2004

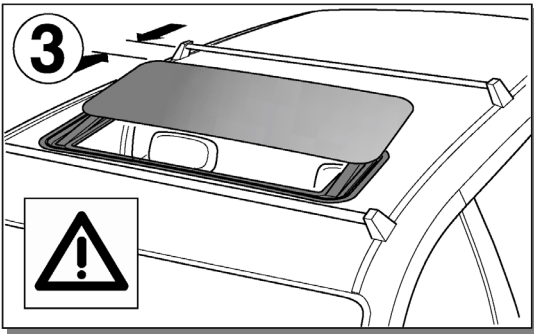
4.2. Special notes

| | |
|-------------------------------------------------------------------------------------|-----------------------------------------------------------------------------------------------------------------------------------------|
|  |  <p>Do not open sunroof when it is raining.</p> |
|  | <p>Drive for at least 5 minutes to dry glass panel before opening.</p> |
|  | <p>When raindrops are removed from glass panel you can open sunroof.</p> |
|  |  <p>Do not to stick out any limbs!</p> |
|  |  <p>Watch out for roof racks!</p> |

Operating Instructions

Sunroof:
Doc.-No.:
Date:

Hollandia 300, 500, 600, 700, 710
0912033A
20-04-2004

4.3. Maintenance

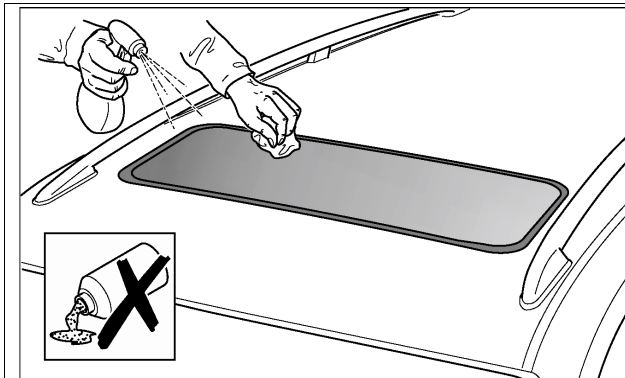

Clean glass panel with glass cleaner.



Do not use scratching substances!

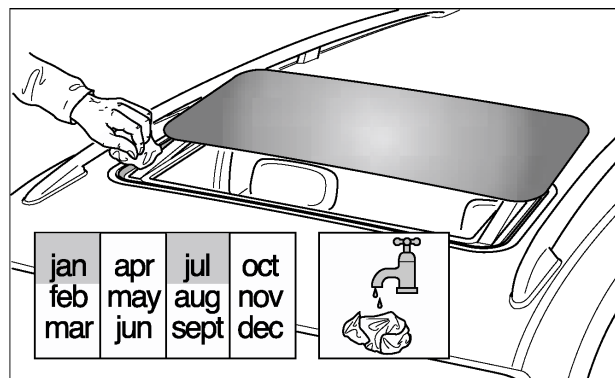
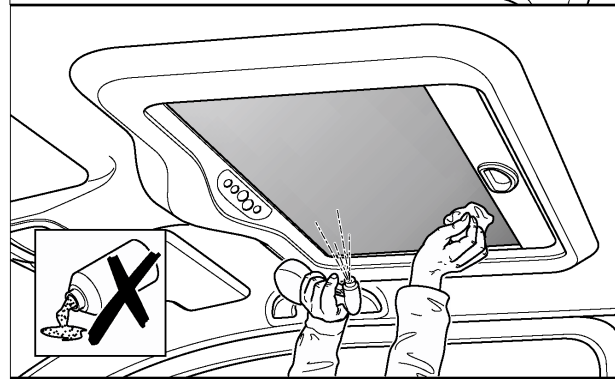

Clean rubber seal with wet cloth at least every half year.

Apply talcum powder to seal to keep rubber flexible.



Do not use grease or oil!

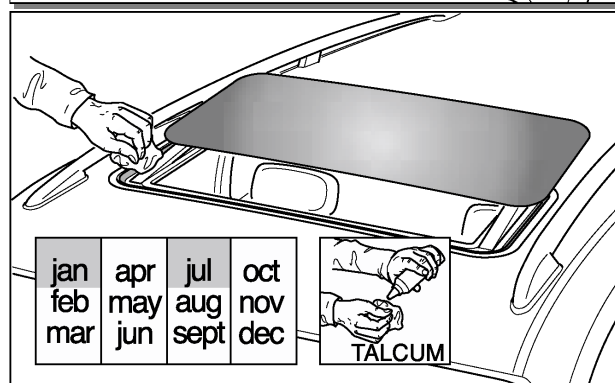

Operating Instructions

Sunroof:
Doc.-No.:
Date:

Hollandia 300, 500, 600, 700, 710
0912033A
20-04-2004

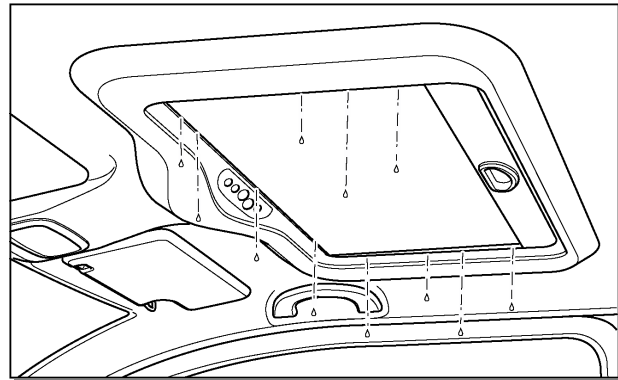

Check seal when sunroof leaks.

Clean seal with a wet cloth.

Apply talcum powder.

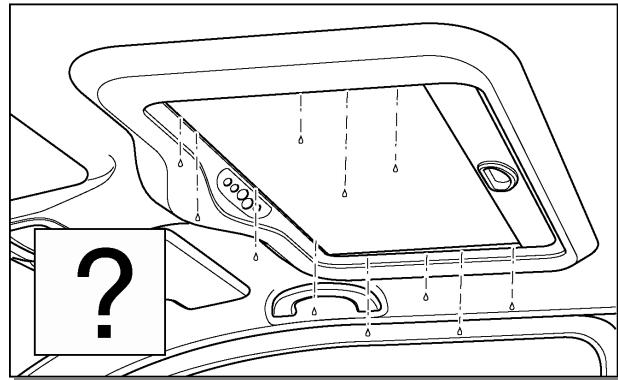
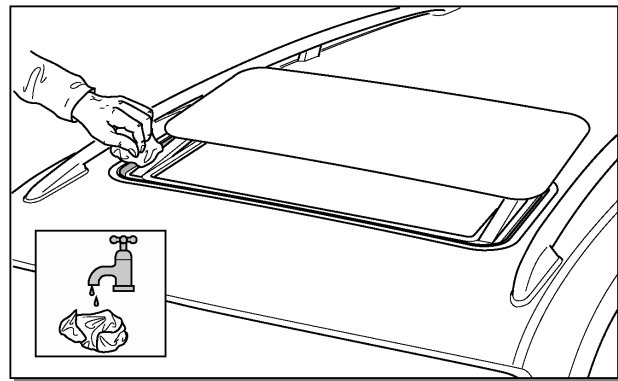

Contact your nearest Webasto-dealer for service, if sunroof still leaks.

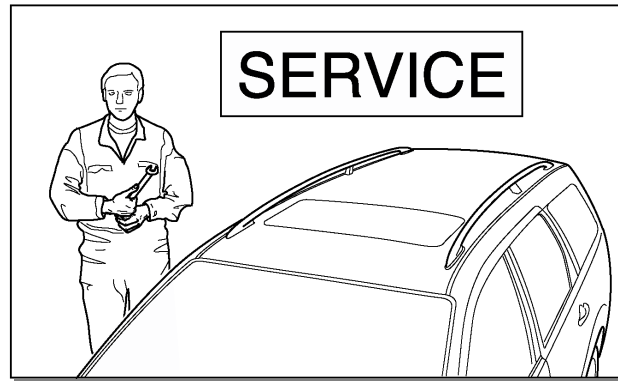

Operating Instructions

Sunroof:
 Doc.-No.:
 Date:

Hollandia 300, 500, 600, 700, 710
 0912033A
 20-04-2004

4.4. Malfunctioning

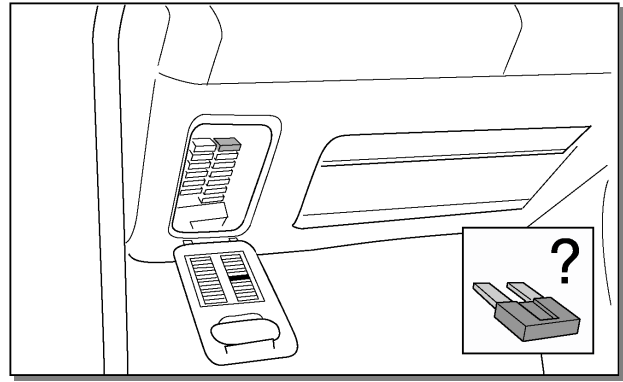
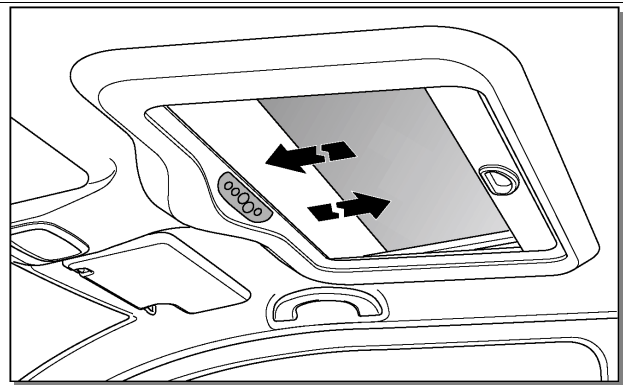
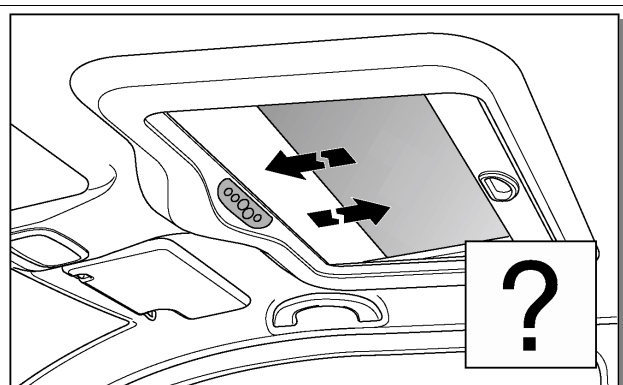
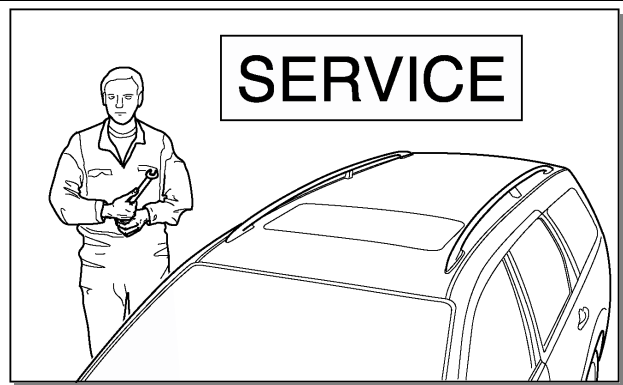
| | |
|-------------------------------------------------------------------------------------|------------------------------------------------------------------------------------------------------------------|
|  | <p>If sunroof does not work at all, check fuse.</p> |
|  | <p>Electronic sunroofs: If sunroof is not working properly, re-program sunroof (see chapter 3.1).</p> |
|  | <p>Check again correct functioning of sunroof.</p> |
|  | <p>When sunroof is still not working properly, contact nearest Webasto dealer for service.</p> |